

# Big Nutball

Drawn by G. Owen.  
Based on a design by  
Josh Bixler @ FliteTest.com

Black Lines - Cut Through

Red Lines - Cut 50% Through

----- Fold Line

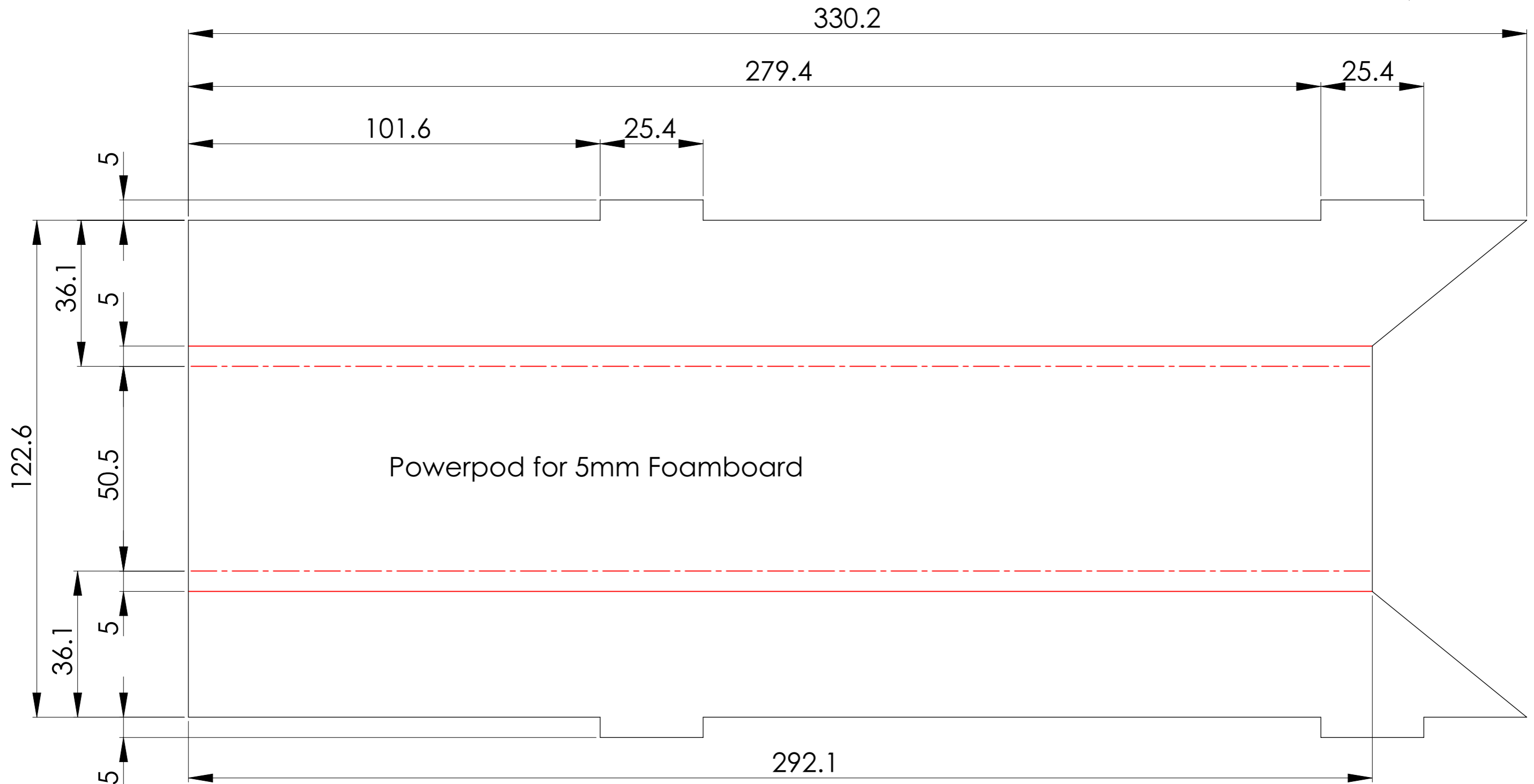
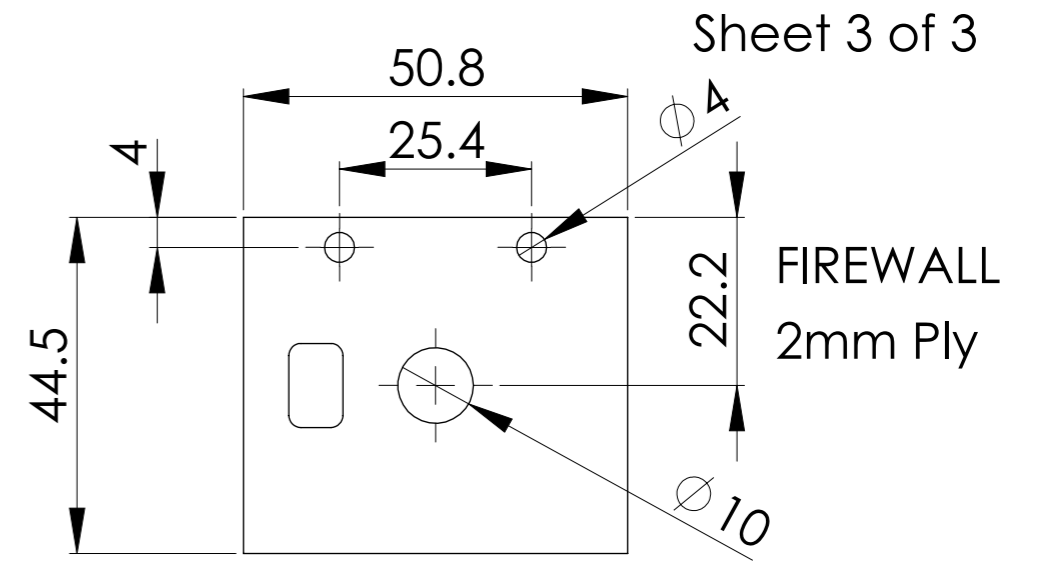

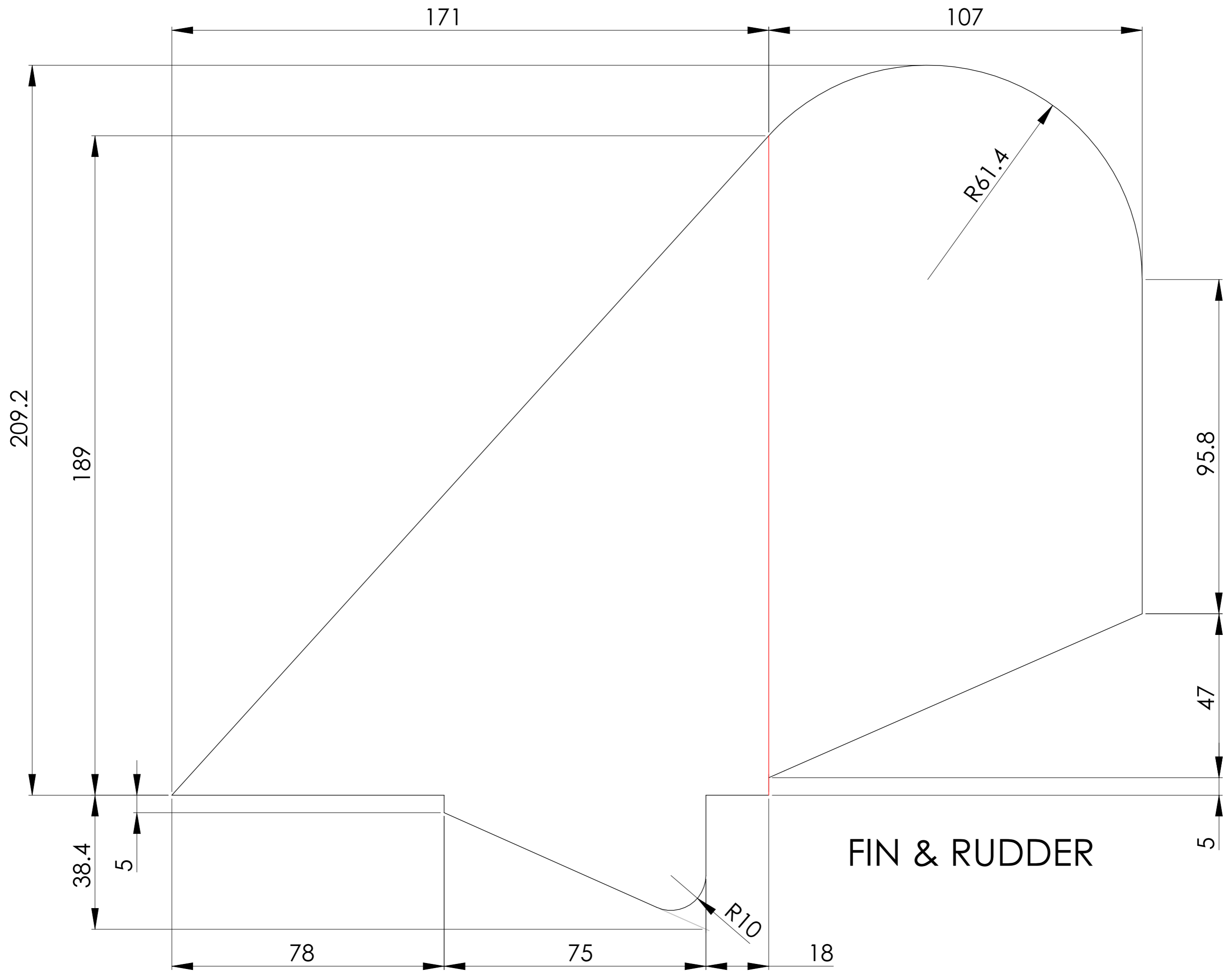

FIN & RUDDER

DIHEDRAL GAUGE -MAKE 2

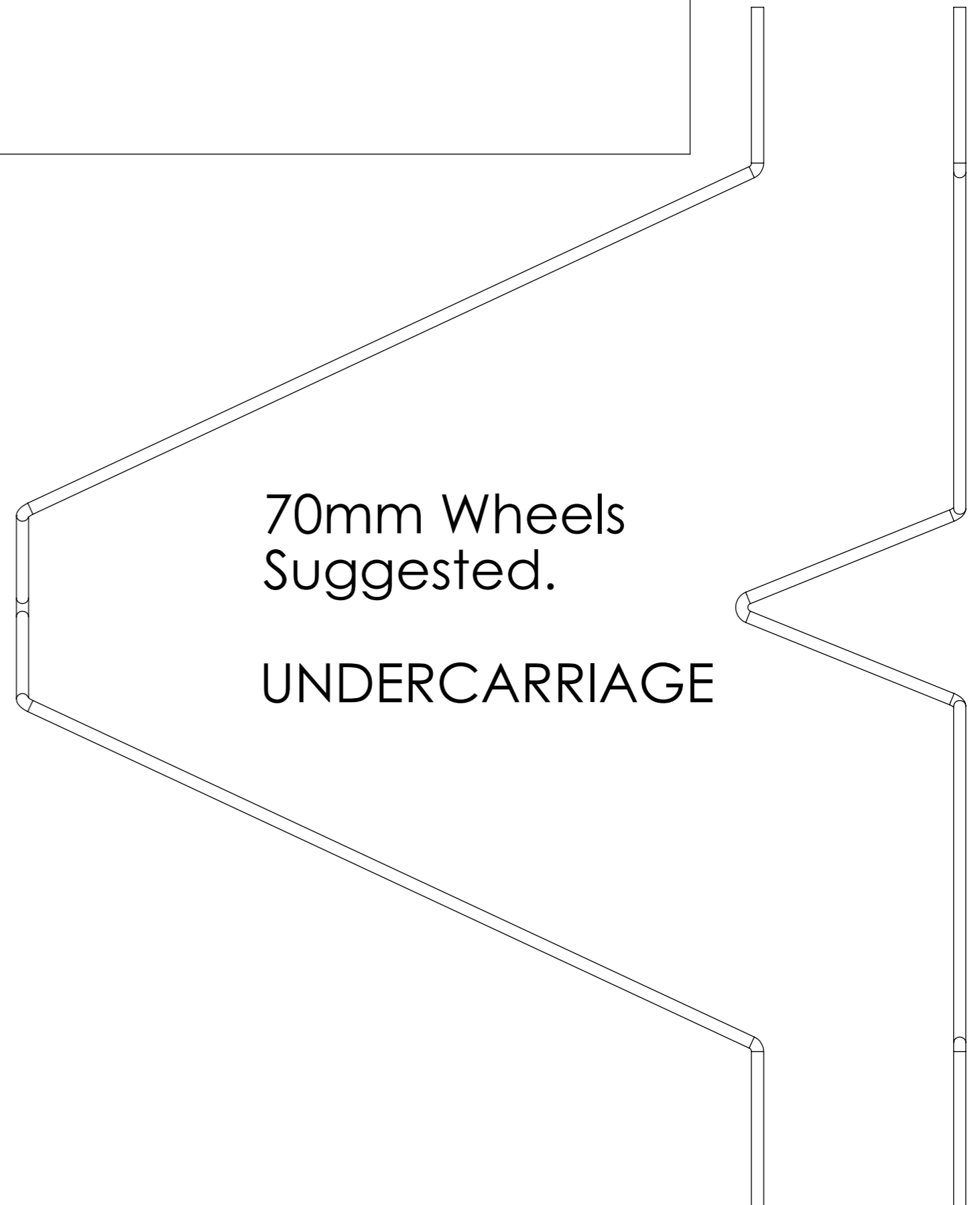

USE BLUE DIAGONAL LINES  
AS AID TO ALIGNING  
PAGES.

MAKE 2 TIPS

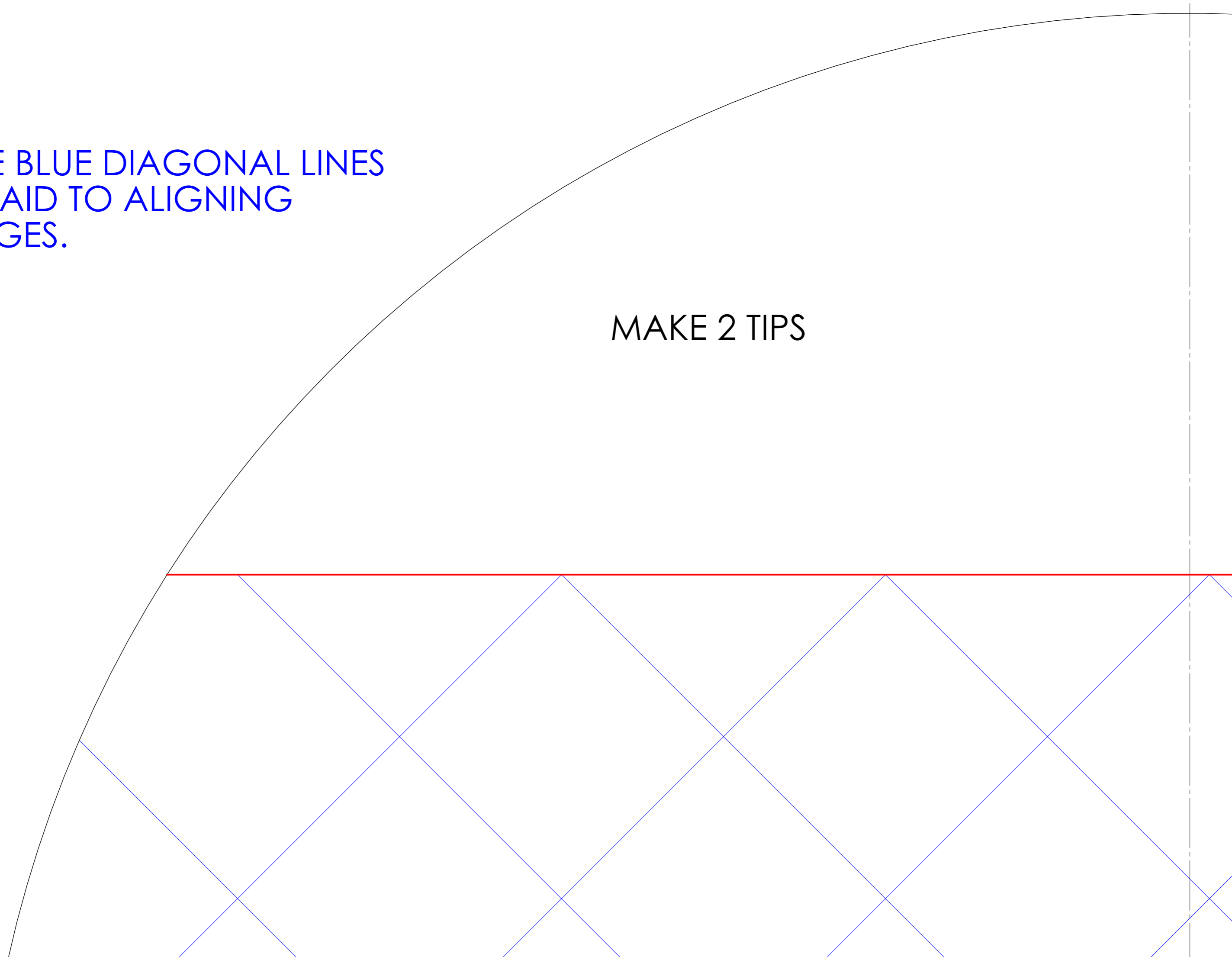

USE BLUE DIAGONAL LINES  
AS AID TO ALIGNING  
PAGES.

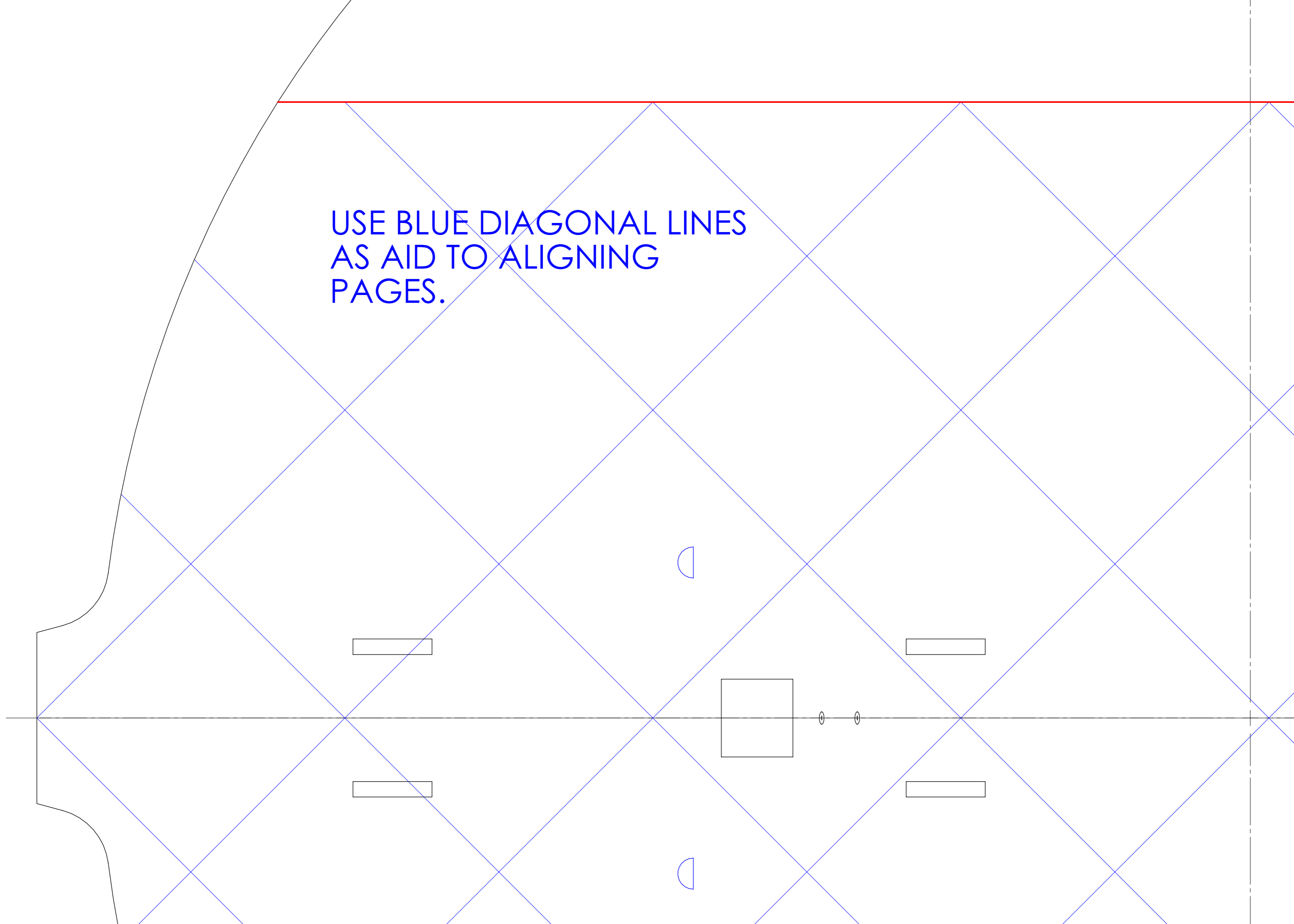

USE BLUE DIAGONAL LINES  
AS AID TO ALIGNING  
PAGES.

USE BLUE DIAGONAL LINES  
AS AID TO ALIGNING  
PAGES.

MAKE 2 TIPS

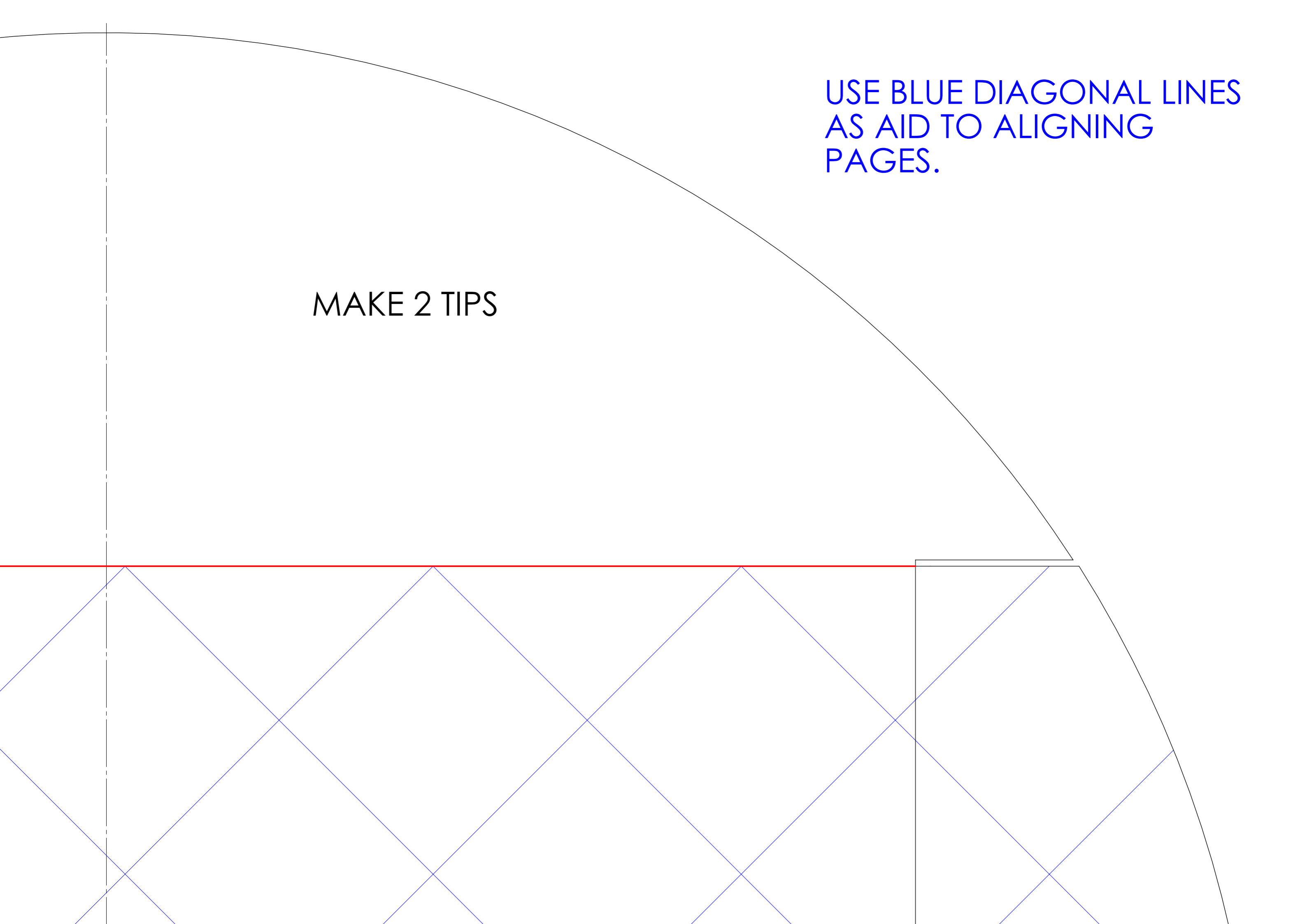



USE BLUE DIAGONAL LINES  
AS AID TO ALIGNING  
PAGES.



The image shows a technical drawing of a page layout. It features a grid of blue diagonal lines forming a diamond pattern. A horizontal dashed line runs across the middle, and a vertical solid line is on the right side. A small rectangular box is centered on the horizontal dashed line. The text 'USE BLUE DIAGONAL LINES AS AID TO ALIGNING PAGES.' is written in blue, bold, uppercase letters in the lower-left quadrant.

USE BLUE DIAGONAL LINES  
AS AID TO ALIGNING  
PAGES.